

VUR/C

VALVOLA UNIDIREZIONALE (TENUTA A CONO)
CHECK VALVE (POPPET TYPE)

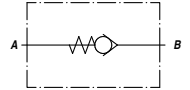
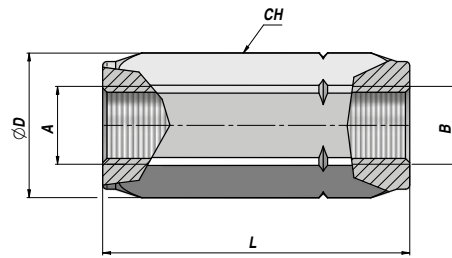
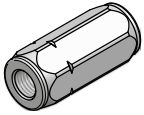

Codice Code	A - B BSP	Q MAX l/min	P MAX bar	Tipo Type	L	ØD	CH	kg
VSG303.C10000	1/4"	30	400	VUR 010-C	58	21	19	0,10
VSG303.C20000	3/8"	50	400	VUR 020-C	62	27	24	0,18
VSG303.C30000	1/2"	90	350	VUR 030-C	71	33	30	0,31
VSG303.C40000	3/4"	130	300	VUR 040-C	83	40	36	0,56
VSG303.C50000	1"	180	270	VUR 050-C	106	59	45	0,91
VSG303.C60000	1"1/4	250	250	VUR 060-C	127	63	55	1,48
VSG303.C70000	1"1/2	380	200	VUR 070-C	138	74	65	2,37

Pressione di apertura - Opening pressure : bar 0.5 (Standard) - 4 - 8

MATERIALE CORPO : ACCIAIO
BODY MATERIAL : STEEL

MONTAGGIO IN LINEA
LINE MOUNTING

VUR/CMF

NEW!

VALVOLA UNIDIREZIONALE (TENUTA A CONO)
CHECK VALVE (POPPET TYPE)

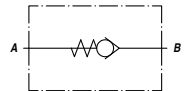
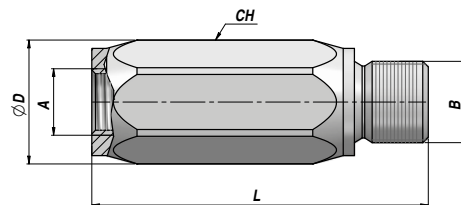

Codice Code	A - B BSP	Q MAX l/min	P MAX bar	Tipo Type	L	ØD	CH	kg
VSG305.C10000	1/4"	30	400	VUR 010-CMF	58	21	19	0,10
VSG305.C20000	3/8"	50	400	VUR 020-CMF	62	27	24	0,18
VSG305.C30000	1/2"	90	350	VUR 030-CMF	71	33	30	0,31
VSG305.C40000	3/4"	130	300	VUR 040-CMF	76	40	36	0,56
VSG305.C50000	1"	180	270	VUR 050-CMF	106	59	45	0,91
VSG305.C60000	1"1/4	250	250	VUR 060-CMF	127	63	55	1,48

Pressione di apertura - Opening pressure : bar 0.5 (Standard) - 4 - 8

MATERIALE CORPO : ACCIAIO
BODY MATERIAL : STEEL

MONTAGGIO IN LINEA
LINE MOUNTING

VALVOLA BIDIREZIONALE (TENUTA A CONO)
BIDIRECTIONAL CHECK VALVE (POPPET TYPE)

NEW!

VRC

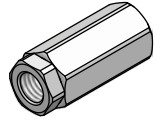
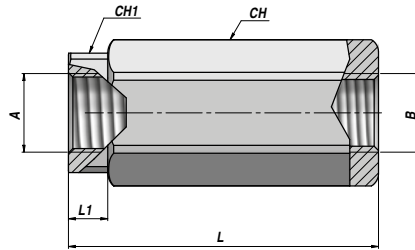
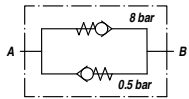

Codice Code	A - B BSP	Q MAX l/min	P MAX bar	Tipo Type	L	L1	CH	CH1	kg
V1590.0606	3/8"	35	350	VRC 3/8"	100	11	30	27	0,45
V1590.0616	1/2"	55	350	VRC 1/2"	118	26	30	27	0,45

Pressione di apertura - Opening pressure : A > B = 0.5 bar

Pressione di apertura - Opening pressure : B > A = 8 bar

MATERIALE CORPO : ACCIAIO
BODY MATERIAL : STEELMONTAGGIO IN LINEA
LINE MOUNTING
VALVOLA UNIDIREZIONALE (TENUTA A CONO)
CHECK VALVE (POPPET TYPE)

NEW!

VU MM

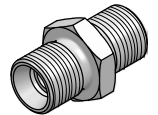
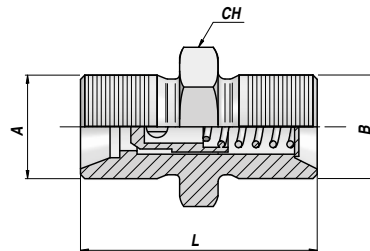
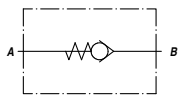

Codice Code	A - B BSP	Q MAX l/min	P MAX bar	Tipo Type	L	CH	kg x 100
V1590.05941	1/4"	8	350	VU MM 1/4"-1	32	19	3,30
V1590.06041	3/8"	20	350	VU MM 3/8"-1	34	22	5,30
V1590.06141	1/2"	50	350	VU MM 1/2"-1	39	27	9,20
V1590.06241	3/4"	90	350	VU MM 3/4"-1	45	32	14,20
V1590.06341	1"	90	320	VU MM 1"-1	55	40	28,80
V1590.06371	1"1/4	250	320	VU MM 1"1/4-1	70	50	59,40
V1590.06381	1"1/2	300	320	VU MM 1"1/2-1	86	55	91,00
V1590.06391	2"	650	320	VU MM 2"-1	102	70	180,00

Pressione di apertura - Opening pressure : VU MM 1/4" > 1" = bar 1 (Standard) - 3 - 6

Pressione di apertura - Opening pressure : VU MM 1"1/4 > 2" = bar 1 (Standard) - 6 - 9

MATERIALE CORPO : ACCIAIO
BODY MATERIAL : STEELMONTAGGIO IN LINEA
LINE MOUNTING

VUI

VALVOLA UNIDIREZIONALE (TENUTA A SFERA)
CHECK VALVE (BALL TYPE)

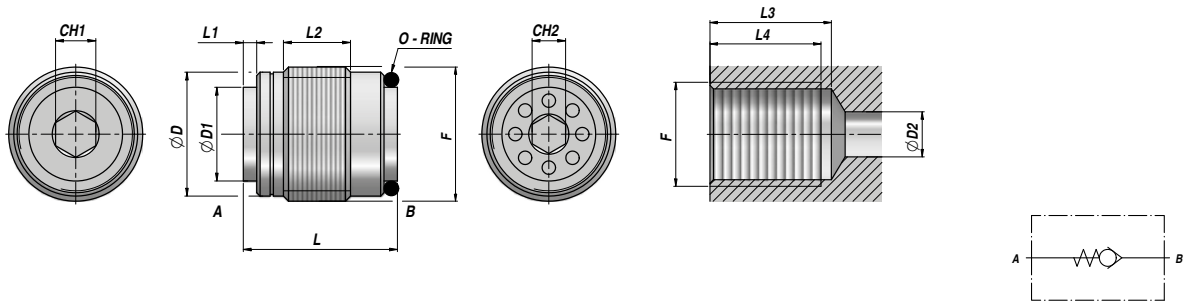

Codice Code	F BSP	Q MAX l/min	P MAX bar	Tipo Type	L	L1	L2	ØD	ØD1	CH1	CH2	L3	L4	ØD2	kg x 100
VCG301.100000	1/4"	18	350	VUI 010	17.0	1.0	6.0	11.3	9.2	3	3	28	25	8	1,00
VCG301.200000	3/8"	25	350	VUI 020	18.5	1.8	7.5	14.8	11.0	4	3	30	27	9	2,00
VCG301.300000	1/2"	50	350	VUI 030	23.0	1.8	9.5	18.5	14.0	6	5	36	32	12	4,00
VCG301.400000	3/4"	78	350	VUI 040	28.5	2.7	14.5	24.0	19.0	8	8	42	37	17	7,00

Pressione di apertura - Opening pressure : bar 0.5

MATERIALE CORPO : ACCIAIO
BODY MATERIAL : STEEL

CARTUCCIA
CARTRIDGE

VRR

NEW!

VALVOLA UNIDIREZIONALE (TENUTA A CONO)
CHECK VALVE (POPPET TYPE)

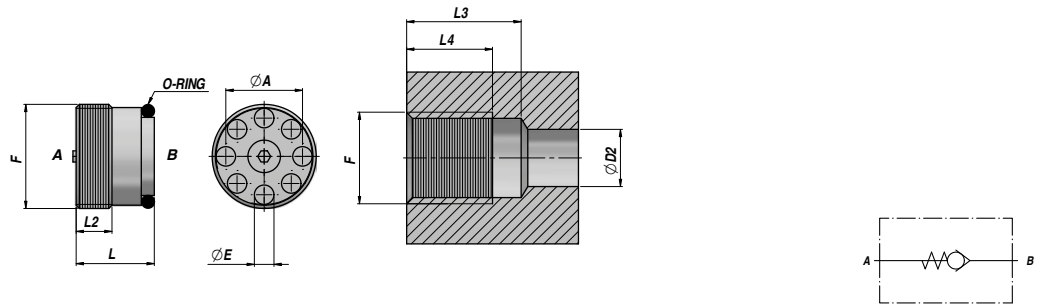

Codice Code	F BSP	Q MAX l/min	P MAX bar	Tipo Type	L	L2	ØA	ØE	L3	L4	ØD2	O-ring	kg x 100
VCG302.010000	1/4"	20	350	VRR 010	8.8	4.2	8.8	2.2	23.5	21.0	7	8x1	1,00
VCG302.020000	3/8"	50	350	VRR 020	12.0	7.0	10.8	3.0	26.5	24.0	9	11x1.5	2,00
VCG302.030000	1/2"	80	350	VRR 030	14.8	8.0	13.8	3.5	31.0	27.5	12	14x1.78	3,00

Pressione di apertura - Opening pressure : bar 0.5

MATERIALE CORPO : ACCIAIO
BODY MATERIAL : STEEL

CARTUCCIA
CARTRIDGE

VALVOLA UNIDIREZIONALE (TENUTA A CONO)
CHECK VALVE (POPPET TYPE)

NEW!

VRR1

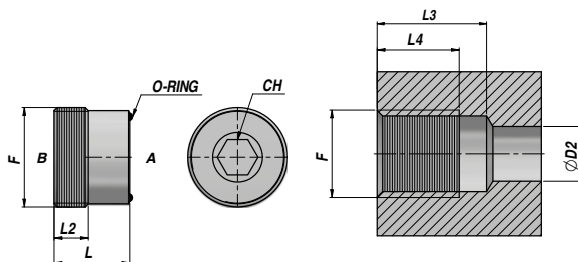
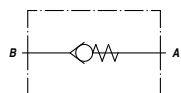
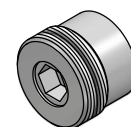

Codice Code	F BSP	Q MAX l/min	P MAX bar	Tipo Type	L	L2	L3	L4	ØD2	CH	O-ring	kg x 100
VCG303.010000	1/4"	20	350	VRR1 010	10.0	6	24.0	21.5	7	5	9x1	1,00
VCG303.020000	3/8"	50	350	VRR1 020	11.5	7	25.5	23.0	9	6	10x1.5	2,00
VCG303.030000	1/2"	80	350	VRR1 030	13.5	8	30.5	28.0	12	8	14.1x1.6	3,00

Pressione di apertura - Opening pressure : bar 0.5

MATERIALE CORPO : ACCIAIO
BODY MATERIAL : STEEL

CARTUCCIA
CARTRIDGE

VALVOLA UNIDIREZIONALE
CHECK VALVE

NEW!

VUC

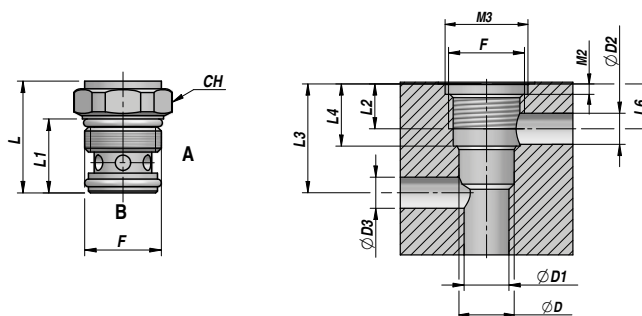
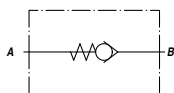

Codice Code	F	Q MAX l/min	P MAX bar	Tipo Type	L	L1	ØD (H7)	L2	L3	L4	L5	L6	ØD1 max	ØD2 max	ØD3	M2	M3	CH	kg x 100
VCS302.200400	3/4-16 UNF	20	350	VUC 020	39.5	27.5	12.7	15	32	20.6	31	13	11	9	9.0	2.7	20.5	22	5,30
VCM302.400050	M22x1.5	40	300	VUC 040	34.5	28.0	19.0	13	33	21.0	32	15	18	9	9.5	3.3	23.0	27	7,50

VUC 020 : TENUTA A SFERA - BALL TYPE

VUC 040 : TENUTA A CONO - POPPET TYPE

Pressione di apertura - Opening pressure : VUC 020: 4 bar - VUC 040: 0.5 bar

MATERIALE CORPO : ACCIAIO
BODY MATERIAL : STEEL

CARTUCCIA
CARTRIDGE

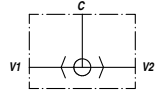
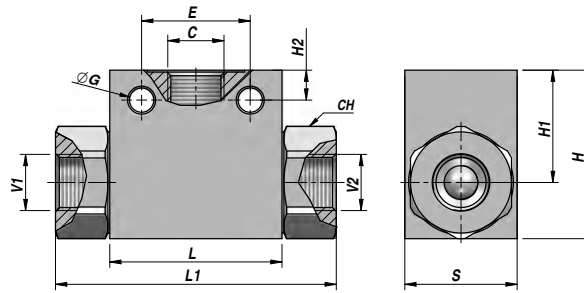
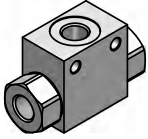

Codice Code	C BSP	V1 - V2 BSP	Q MAX l/min	P MAX bar	Tipo Type	L	L1	ØG	E	H2	CH	H1	H	S	kg
VSG390.100000	1/4"	1/4"	35	500	VU/SF 010	36	69	5.5	25	7.5	22	22.5	35	25	0,27
VSG390.200000	3/8"	3/8"	50	500	VU/SF 020	45	75	6.5	29	8.0	27	30.0	45	30	0,46
VSG390.300000	1/2"	1/2"	90	500	VU/SF 030	57	94	5.5	36	9.0	30	32.0	50	35	0,74
VSG390.400000	3/4"	3/4"	140	350	VU/SF 040	65	100	6.5	50	6.5	41	37.5	60	50	1,41
VSG390.500000	1"	1"	180	300	VU/SF 050	80	126	10.5	60	11.0	46	54.5	80	50	1,87

MATERIALE CORPO : ACCIAIO
BODY MATERIAL : STEEL

MONTAGGIO IN LINEA
LINE MOUNTING