

**COMPONENTI INOX  
STAINLESS STEEL COMPONENTS**

	Descrizione - Description	Type	Page
	TESTATA DI GUIDA IN INOX STAINLESS STEEL HEAD BUSH	CGXX	176
	KIT GUARNIZIONI SEAL KITS	GKG	176
	FONDELLO IN INOX STAINLESS STEEL END PLUG	CFX	177
	FONDELLO IN INOX CON FORO ED ENTRATA OLIO STAINLESS STEEL END PLUG WITH CROSS HOLE AND INLET PORT	CFEX	177
	BORCHIA FILETTATA IN INOX STAINLESS STEEL THREADED PORT	CBSX	177
	BOCCOLA IN INOX STAINLESS STEEL BUSH	CBX	178
	OCCHIO FISSO IN INOX STAINLESS STEEL MALE CLEVIS	COFX	178
	FORCELLA FILETTATA IN INOX STAINLESS STEEL THREADED FORK	CFFX	178
	ANELLO A SALDARE IN INOX PER SNODO "GE TGR" STAINLESS STEEL WELD-RING FOR "GE TGR" BALL-JOINT	CAGEX	179
	SNODO SFERICO RADIALE NON RICHIEDENTE MANUTENZIONE MAINTENANCE FREE RADIAL BALL-JOINT	GE TGR	179

**CGXX**

TESTATA DI GUIDA IN INOX  
STAINLESS STEEL HEAD BUSH

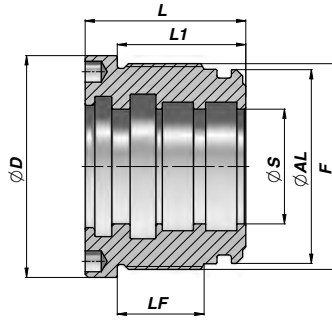

Codice Code	ØAL	ØS	ØD	F	LF	L	L1	kg	Set guarnizioni Seal kits
CGXX050040020	40	20	49	M44x1.5	19	40	32	0,28	GKCGXX040020
CGXX050040025	40	25	49	M44x1.5	19	40	32	0,23	GKCGXX040025
CGXX060050025	50	25	59	M54x1.5	22	43	35	0,46	GKCGXX050025
CGXX060050030	50	30	59	M54x1.5	22	43	35	0,39	GKCGXX050030
CGXX070060030	60	30	69	M64x1.5	27	50	40	0,80	GKCGXX060030
CGXX070060035	60	35	69	M64x1.5	27	50	40	0,70	GKCGXX060035
CGXX070060040	60	40	69	M64x1.5	27	50	40	0,60	GKCGXX060040
CGXX080070035	70	35	79	M74x1.5	27	50	40	1,06	GKCGXX070035
CGXX080070040	70	40	79	M74x1.5	27	50	40	0,94	GKCGXX070040
CGXX095080040	80	40	94	M85x2	33	60	50	1,90	GKCGXX080040

MATERIALE : AISI 316 ACCIAIO INOSSIDABILE

MATERIAL : AISI 316 STAINLESS STEEL

**GKCGXX**

KIT GUARNIZIONI PER TESTATA DI GUIDA "CGXX"  
SEAL KITS FOR "CGXX" HEAD BUSH

Codice Code	Alesaggio/Stelo Bore/Rod	GAF	GHK	O-Ring Dowty	TTI-L TTI - TSE	O-Ring Dowty
						GDS
GKCGXX040020	40 / 20	TEF-SEAL 03-6325	078110	126	TTI 20-28/L	219
GKCGXX040025	40 / 25	n°2 25x30x5.6	098129	126	TTI 25-33/L	219
GKCGXX050025	50 / 25	n°2 25x30x5.6	098129	132	TTI 25-35/L	826
GKCGXX050030	50 / 30	n°2 30x35x5.6	118149	132	TTI 30-40/1L	826
GKCGXX060030	60 / 30	n°2 30x35x9.7	118149	138	TTI 30-40/1L	832
GKCGXX060035	60 / 35	n°2 35x40x9.7	137169	138	TTI 35-45/L	832
GKCGXX060040	60 / 40	n°2 40x45x9.7	157188	138	TTI 40-48/L	832
GKCGXX070035	70 / 35	n°2 35x40x9.7	137169	145	TTI 35-45/L	839
GKCGXX070040	70 / 40	n°2 40x45x5.6	157188	145	TTI 40-50/3L	839
GKCGXX080040	80 / 40	n°2 40x45x9.7	157188	149	TTI 40-50/3L	GDS 845

FONDELLO IN INOX  
STAINLESS STEEL END PLUG

CFX

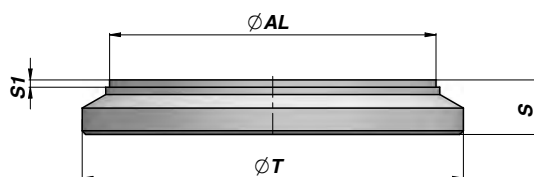

Codice Code	ØAL	ØT	S	S1	kg
CFX00040050	40	50	10	2	0,13
CFX00050060	50	60	10	2	0,19
CFX00060070	60	70	12	2	0,33
CFX00070080	70	80	12	2	0,43
CFX00080095	80	95	12	2	0,60

MATERIALE : AISI 316 ACCIAIO INOSSIDABILE  
MATERIAL : AISI 316 STAINLESS STEEL

FONDELLO IN INOX CON FORO ED ENTRATA OLIO  
STAINLESS STEEL END PLUG WITH CROSS HOLE AND INLET PORT

CFEX

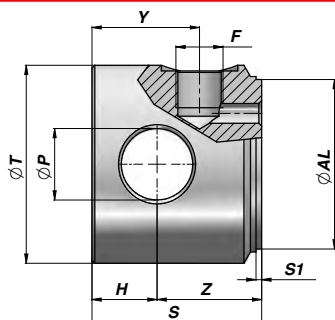
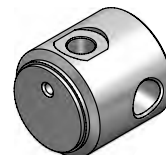

Codice Code	ØAL	ØT	ØP	Z	H	F BSP	Y	S	S1	kg
CFEX040050416	40	50	16.20	35	15	1/4"	30	50	2	0,60
CFEX050060620	50	60	20.25	40	20	3/8"	38	60	2	1,10
CFEX060070625	60	70	25.25	37	23	3/8"	38	60	2	1,40
CFEX070080625	70	80	25.25	37	23	3/8"	38	60	2	1,95

MATERIALE : AISI 316 ACCIAIO INOSSIDABILE  
MATERIAL : AISI 316 STAINLESS STEEL

BORCHIA FILETTATA IN INOX  
STAINLESS STEEL THREADED PORT

CBSX

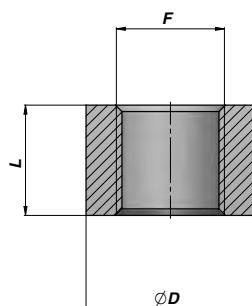
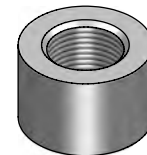

Codice Code	F BSP	L	ØD	kg x 100
CBSX040000	1/4"	15	20	3,00
CBSX060000	3/8"	17	26	4,00
CBSX080000	1/2"	20	32	4,00

MATERIALE : AISI 316 ACCIAIO INOSSIDABILE  
MATERIAL : AISI 316 STAINLESS STEEL

**CBX**

**BOCCOLA IN INOX  
STAINLESS STEEL BUSH**

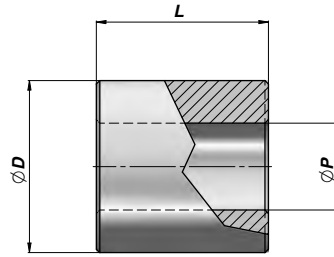

Codice Code	ØP	ØD	L	kg
CBX016035030	16.20	35	30	0,18
CBX020040040	20.25	40	40	0,29
CBX025050050	25.25	50	50	0,56
CBX030060060	30.25	60	60	0,97

MATERIALE : AISI 316 ACCIAIO INOSSIDABILE  
MATERIAL : AISI 316 STAINLESS STEEL

**COFX**

**OCCHIO FISSO IN INOX  
STAINLESS STEEL MALE CLEVIS**

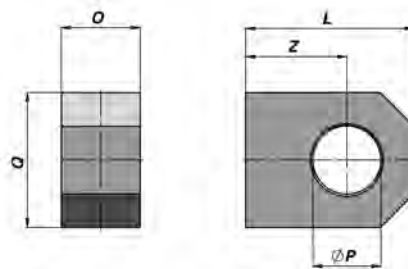
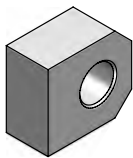

Codice Code	ØP	Q	Z	L	kg
COFX0200000	20.25	25	45	30	0,35

MATERIALE : AISI 316 ACCIAIO INOSSIDABILE  
MATERIAL : AISI 316 STAINLESS STEEL

**CFFX**

**FORCELLA FILETTATA IN INOX  
STAINLESS STEEL THREADED FORK**

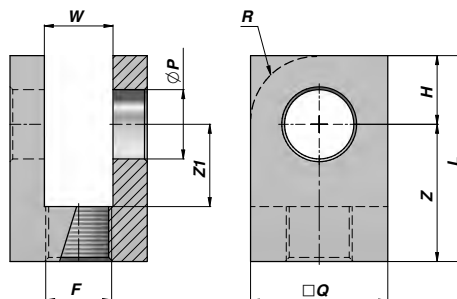
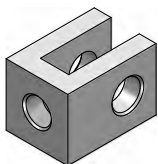

Codice Code	ØP	L	Z	Z1	H	Q	W	F	kg
CFFX0161615	16.20	55	39	24	16	35	16	M16x1.5	0,30
CFFX0202015	20.25	65	45	30	20	40	20	M20x1.5	0,40
CFFX0252420	25.25	75	50	30	25	50	25	M24x2	0,75

MATERIALE : AISI 316 ACCIAIO INOSSIDABILE  
MATERIAL : AISI 316 STAINLESS STEEL

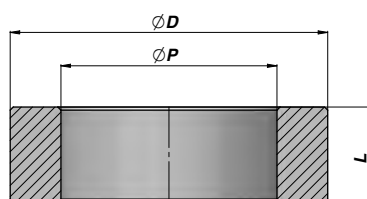
**ANELLO A SILDARE IN INOX PER SNODO "GE TGR"**  
**STAINLESS STEEL WELD-RING FOR "GE TGR" BALL-JOINT**
**CAGEX**

Codice Code	Per For	ØD	L	ØP	kg
CAGEX050035	GE ø20	50	14	35	0,11
CAGEX069042	GE ø25	69	19	42	0,35
CAGEX075047	GE ø30	75	20	47	0,41
CAGEX094062	GE ø40	94	26	62	0,79

MATERIALE : AISI 316 ACCIAIO INOSSIDABILE

MATERIAL : AISI 316 STAINLESS STEEL

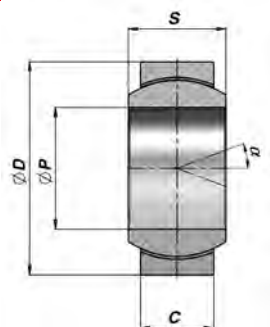
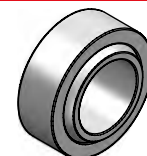
**SNODO SFERICO RADIALE NON RICHIEDENTE MANUTENZIONE**  
**MAINTENANCE FREE RADIAL BALL-JOINT**
**GE TGR**

Codice Code	ØP	ØD	S	C	α	FC	kg
CGE0003603	20	35	16	12	9	41.5	0,06
CGE0003604	25	42	20	16	7	68.0	0,12
CGE0003605	30	47	22	18	6	88.0	0,16
CGE0003607	40	62	28	22	7	140.0	0,32

FC = CARICO DINAMICO AMMESSO - MAX DYNAMIC LOAD

ACCOPPIAMENTO - COUPLING : ACCIAIO/PTFE - STEEL/PTFE

MATERIALE : ACCIAIO INOSSIDABILE AISI420 - ISO 12240-1 SERIE G

MATERIAL : STAINLESS STEEL AISI420 - ISO 12240-1 SERIE G